

DIMENSIONS

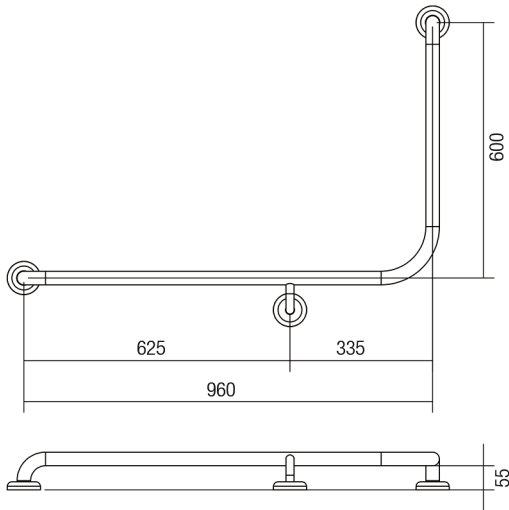

Drawn LH (Left Hand)

INDICATIVE IMAGE



CLAM FLANGE® - TOILET GRAB RAILS

Product Code - Finish

- CF 966 PS LH - Polish Supreme™

Features

- 960 mm x 600 mm
- 78 mm pre-formed domed CLAM FLANGE®
- Clam plate is fully welded to 32 mm rail for maximum strength
- Clam flange cover is a firm press fit to clam plate
- Fabricated from 304 stainless steel
- Inside of grab rail has been cleaned and free of unsanitary oil and dirt produced through fabrication processes
- Stainless steel fixing screws supplied

Optional Extras - Toilet Roll Holder



- TR 031

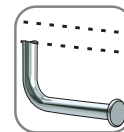

- TR 031 S
Factory Fitted

Warranty

See Tubotech™ warranty policy for full details.

DIMENSIONS

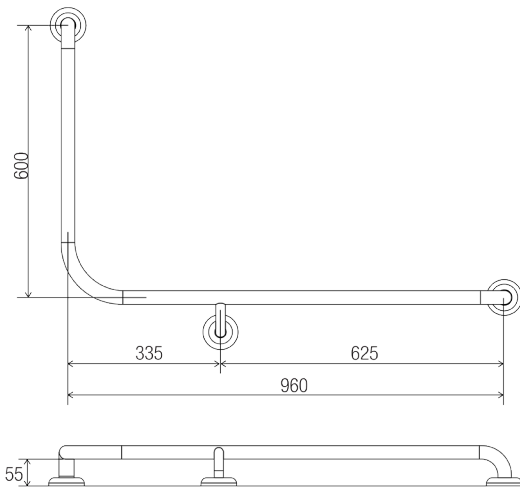

Drawn RH (Right Hand)

INDICATIVE IMAGE



CLAM FLANGE® - TOILET GRAB RAILS

Product Code - Finish

- CF 966 PS RH - Polish Supreme™

Features

- 960 mm x 600 mm
- 78 mm pre-formed domed CLAM FLANGE®
- Clam plate is fully welded to 32 mm rail for maximum strength
- Clam flange cover is a firm press fit to clam plate
- Fabricated from 304 stainless steel
- Inside of grab rail has been cleaned and free of unsanitary oil and dirt produced through fabrication processes
- Stainless steel fixing screws supplied

Optional Extras - Toilet Roll Holder



- TR 031

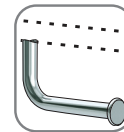

- TR 031 S
Factory Fitted

Warranty

See Tubotech™ warranty policy for full details.